



شركة الصناعات الوطنية  
NATIONAL INDUSTRIES COMPANY  
www.nicbm.com | 1844 555  
@national\_industries



## Limestone & Decoration Bricks & Blocks Cement Cladding Bricks & Blocks



Catalogues



# NIC Products



LED Lights



Limestone



Interlock & Yard Tiles



Plastics



Cement Cladding Bricks



White Blocks



Ready Mix



Dry Mortar



Cladding Materials



Benches & Flower Pots



Ceramics



Paints



HDPE



NI Panels



Concrete Pipes

# NIC Limestone Bricks

NIC limestone considered a diverse product Of the National Industries Company which has more than forty years of experience in manufacturing and marketing it locally and in the GCC states. It is considered one of the most prominent and oldest cladding material available in the local market in the State of Kuwait.

The National Industries Company is considered a pioneer company in this field. It is the only one that produces this kind of bricks since 1960, when the first production of limestone bricks in Kuwait began.

The first internationally produced limestone brick was manufactured in Britain in 1866. It continues to witness increasing interest in all countries in the world – including Kuwait – thus maintaining its history which guaranteed its continuity.

The product development process for meeting the evolving and various taste of clients is one of the main priorities of the National Industries Company. Therefore, several types of limestone of the Industries is produced: standard limestone blocks with different sizes, royal bricks, Industries stone, decoration bricks and limestone blocks. They are also produced in different colors and shapes. They can be used together in the same building, which will provide the client with the beauty of the construction which s/he always wanted.

The most difficult and most precise designs can be executed using

the Industries limestone. This allows the client to have a unique construction. It is also easy and quickly completed. It uses brackets, oriel windows, fences and entrances in the buildings from the inside to add a touch of beauty.

The limestone bricks have a high density and breaking point that allow them to bear the compaction under high heights without being subject to any kind of breaking or fractures, provided that the correct installation means are used. These bricks are considered the best cladding material aiding in thermal and acoustic insulation, along with white insulating bricks, as compared to other products.

The limestone brick products have accurate dimensions and are equal in model or size. This aids in decreasing the amount of mortar used during the construction operation.

And finally, the competitive prices of the limestone bricks of the Industries helps decrease the burdens and expenses of construction for any project. It is unique in the sense that it requires less maintenance which is expensive and difficult in daily life. It is one of the best cladding products.



# Limestone with Smooth Surface

NIC provides limestone bricks of various sizes, shapes and colors to suit the diverse needs and tastes of the company's customers.

Here are the types of soft limestone blocks without engravings

Subsized



138010

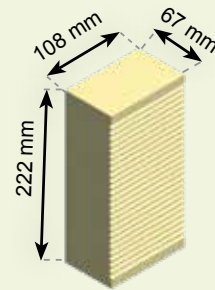

## Standard 1

- Weight: 3.1 kg
- 56 pieces/m<sup>2</sup>

Subsized



138020

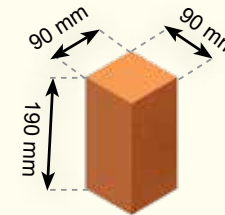

## Standard 2

- Weight: 2.95 kg
- 50 pieces/m<sup>2</sup>



138060

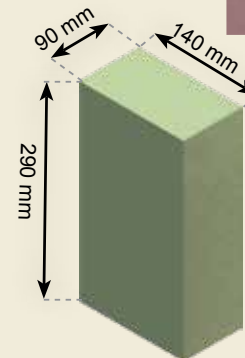

## Standard 6

- Weight: 6.85 kg
- 22 pieces/m<sup>2</sup>

Subsized



138070

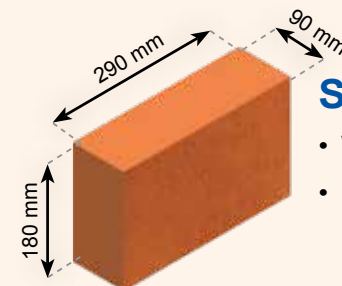

## Standard 7

- Weight: 9 kg
- 18 pieces/m<sup>2</sup>

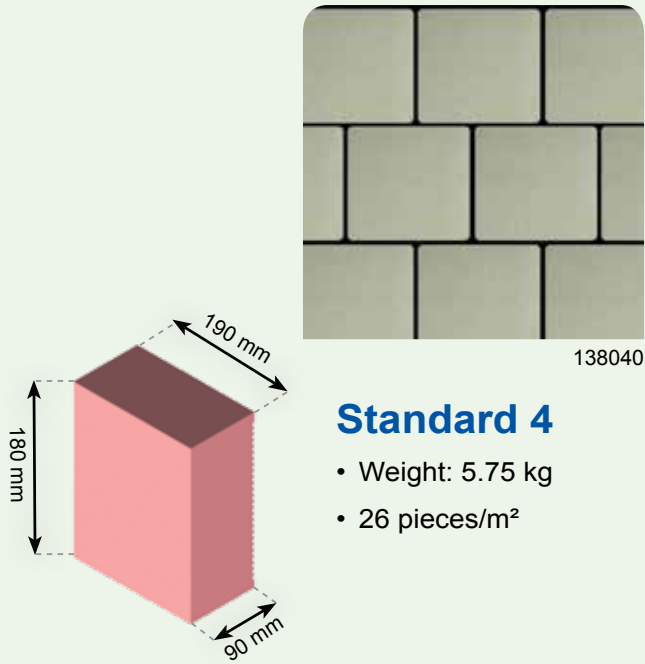

### Standard 4

- Weight: 5.75 kg
- 26 pieces/m<sup>2</sup>

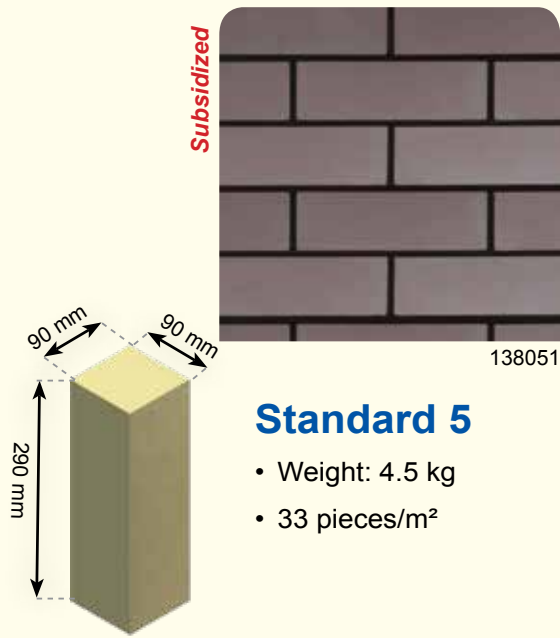

### Standard 5

- Weight: 4.5 kg
- 33 pieces/m<sup>2</sup>

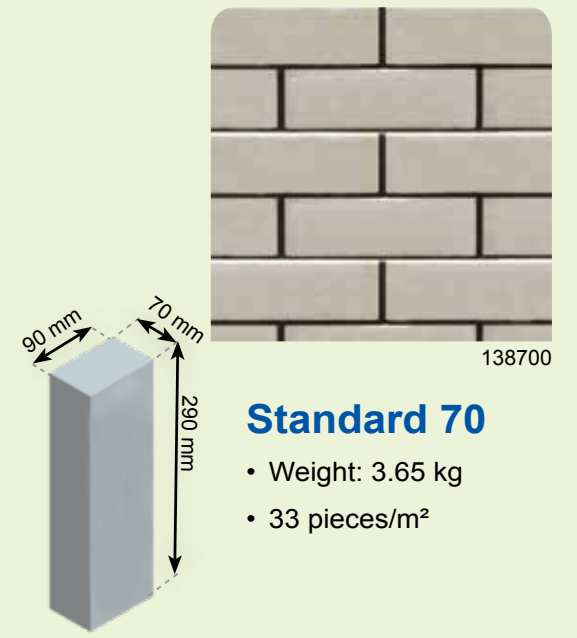

### Standard 70

- Weight: 3.65 kg
- 33 pieces/m<sup>2</sup>

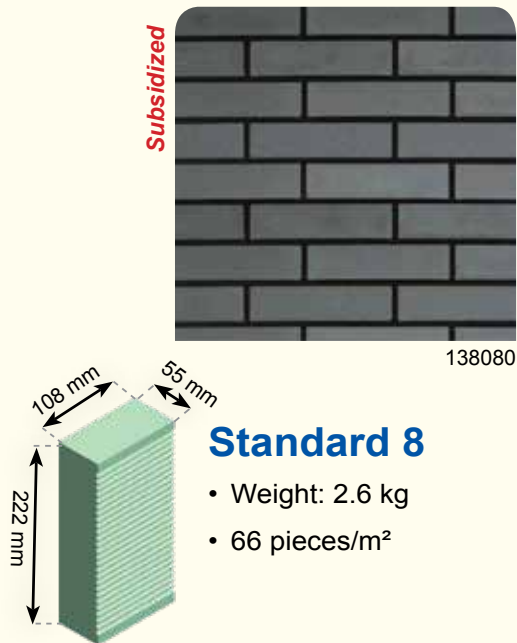

### Standard 8

- Weight: 2.6 kg
- 66 pieces/m<sup>2</sup>

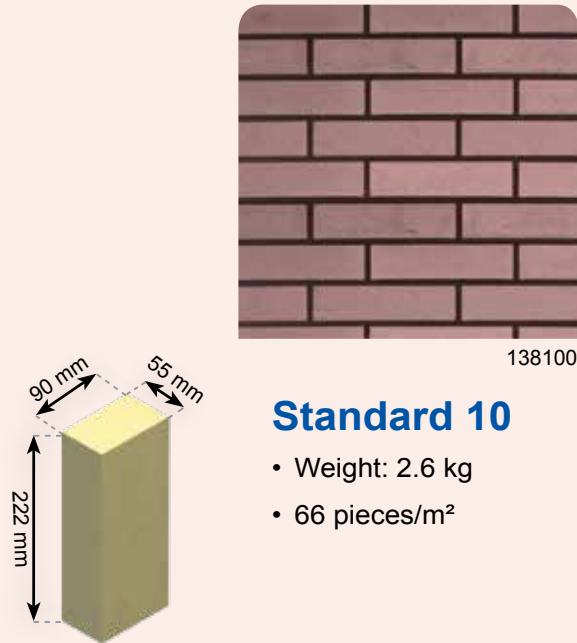

### Standard 10

- Weight: 2.6 kg
- 66 pieces/m<sup>2</sup>

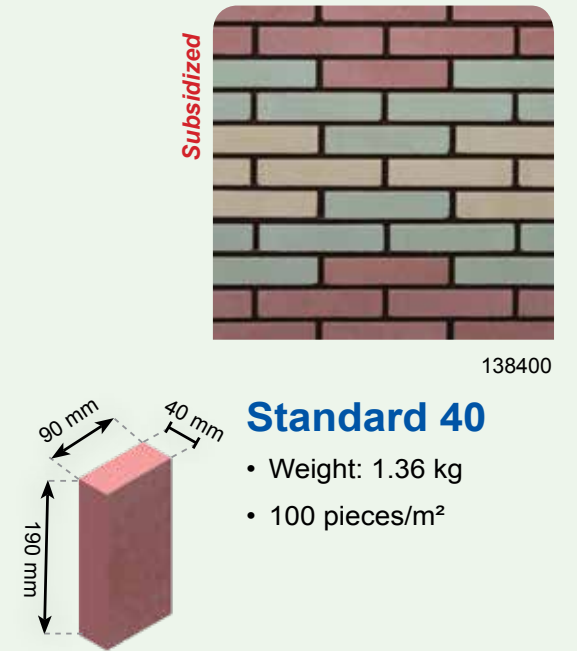

### Standard 40

- Weight: 1.36 kg
- 100 pieces/m<sup>2</sup>

# Limestone with Raugh Surface

The company also provides types of limestone bricks with rough surfaces to suit wider collections of modern building cladding designs

Subsized



138300

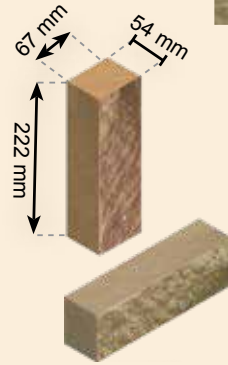

## Standard 30

- Weight: 1.55 kg
- 56 pieces/m<sup>2</sup>

Subsized



138310

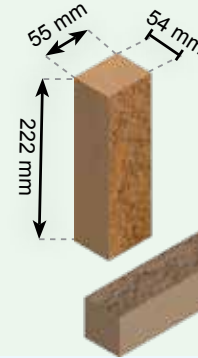

## Standard 31

- Weight: 1.3 kg
- 66 pieces/m<sup>2</sup>

Subsized



138320

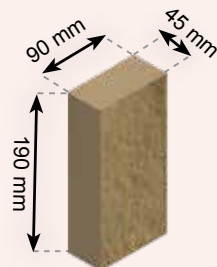

## Standard 32

- Weight: 1.48 kg
- 56 pieces/m<sup>2</sup>



138330

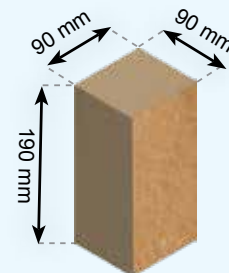

## Standard 33

- Weight: 2.88 kg
- 50 pieces/m<sup>2</sup>

Subsized



138340

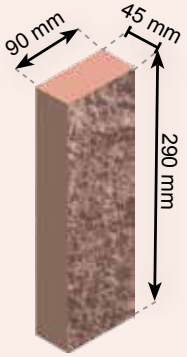

### Standard 34

- Weight: 2.25 kg
- 33 pieces/m<sup>2</sup>

Subsized



138350

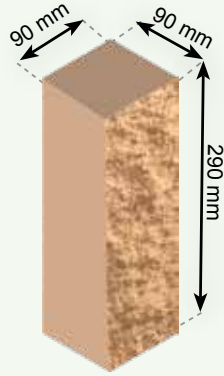

### Standard 35

- Weight: 4.5 kg
- 33 pieces/m<sup>2</sup>



138360

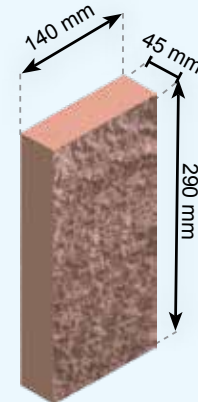

### Standard 36

- Weight: 3.5 kg
- 22 pieces/m<sup>2</sup>

# Textured Limestone

In response to the local and regional market needs to provide new forms of large sizes, NIC has introduced various forms of different discussions to suit the modern cladding requirements.

The available engravings are Mosaic 1 cm edge and 2 cm edge, Dana, Jawhara, Petra, Chamfered, Curved, Protruded, Rough Protruded.



Subsized



138194

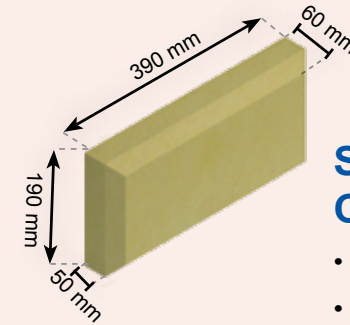

## Standard 19 Chamfered

- Weight: 7.5 kg
- 13 pieces/m<sup>2</sup>

Subsized



138191

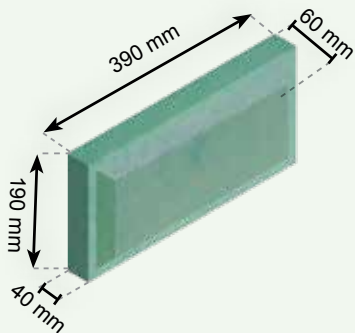

## Standard 19 Jawhara

- Weight: 7.5 kg
- 13 pieces/m<sup>2</sup>

Subsized



138701

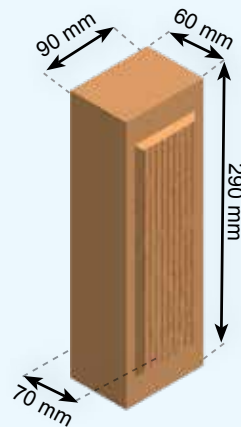

## Standard 70 Rough Protruded

- Weight: 3.65 kg
- 33 pieces/m<sup>2</sup>

Subsized



138704

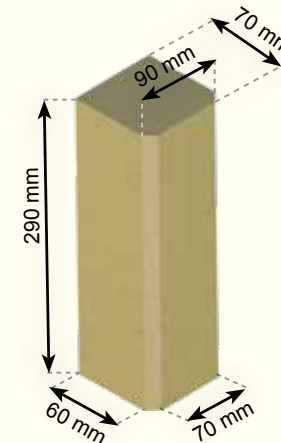

## Standard 70 Chamfered

- Weight: 3.65 kg
- 33 pieces/m<sup>2</sup>

Subsidized



### Standard 19 Dana

- Weight: 7.5 kg
- 13 pieces/m<sup>2</sup>

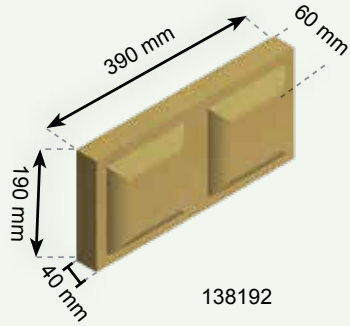

Subsidized



### Standard 70 Curved

- Weight: 3.65 kg
- 33 pieces/m<sup>2</sup>

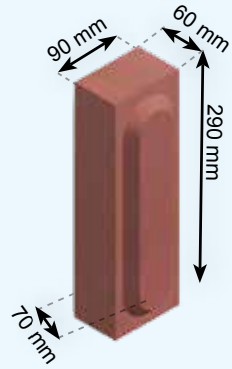

138702

Subsidized



### Standard 19 Petra

- Weight: 7.5 kg
- 13 pieces/m<sup>2</sup>

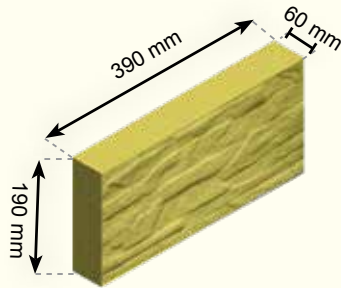

138199

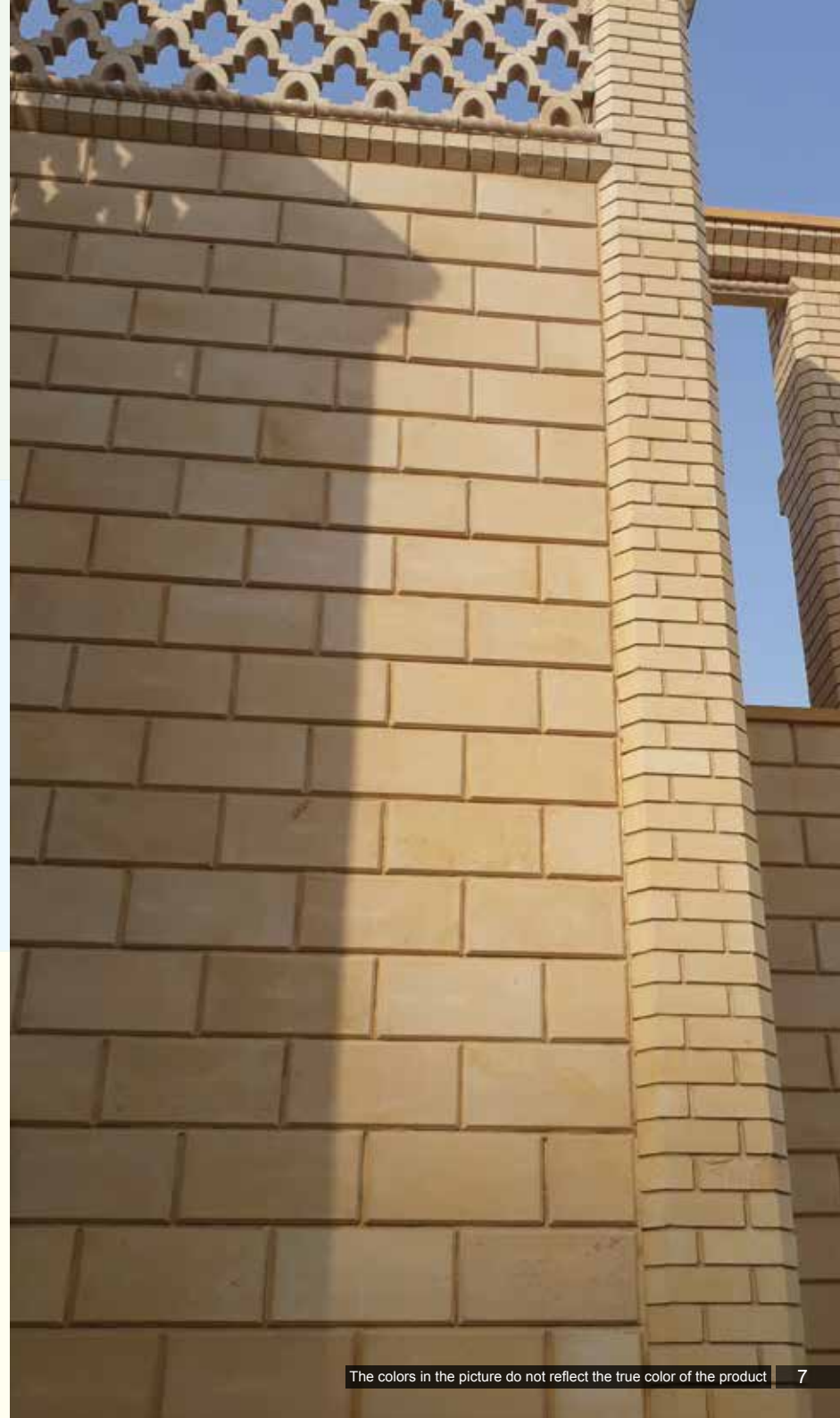

# Stone Bricks

The Stone species is a kind of limestone bricks, characterized either with a rough surface makes its look closer to the natural stone such as the "Tubza", "Kuwaiti Stone" and "Stone 15", or with its textured surface such as "Amwaj" and "Islamic".



143010



Subsidized

143020



143050

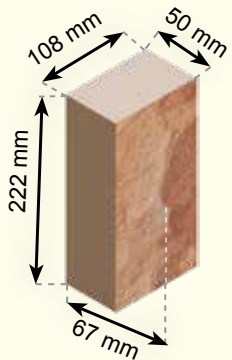

## Kuwaiti Stone

- Weight: 3.15 kg
- 56 pieces/m<sup>2</sup>

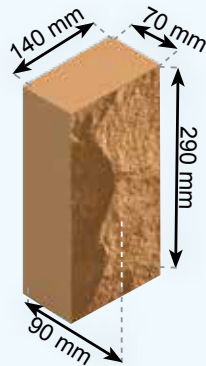

## NIC Stone Tubza

- Weight: 5.35 kg
- 22 pieces/m<sup>2</sup>

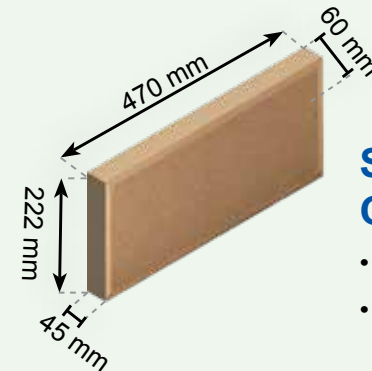

## Stone 22 Chamfered

- Weight: 10.5 kg
- 9 pieces/m<sup>2</sup>

Subsized



143021

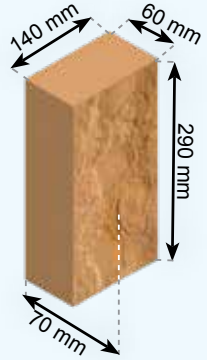

### NIC Stone Aamwaj

- Weight: 6 kg
- 22 pieces/m<sup>2</sup>

Subsized



143030

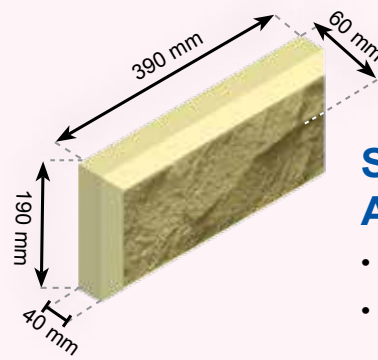

### Stone 19 Andalusi

- Weight: 7.5 kg
- 13 pieces/m<sup>2</sup>



138242

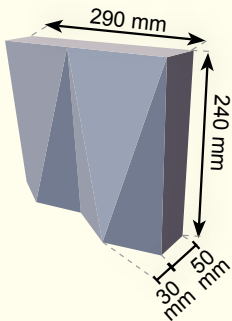

### Diwan Stone

- Weight: 8.5 kg
- 14 pieces/m<sup>2</sup>



143271



### Stone Muattaq

- Weight: 0.88 kg
- 56 pieces/m<sup>2</sup>



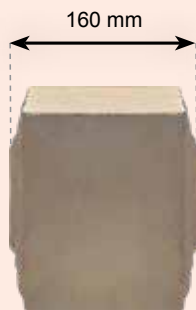
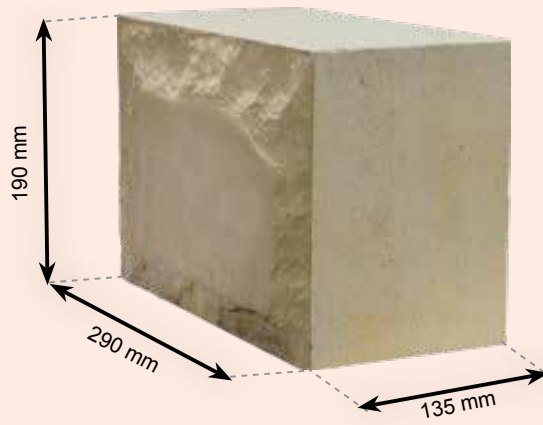

Double Side  
143150

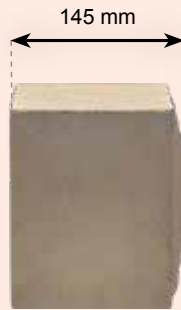

One Side  
143151

### Stone 15

- **Single Side**  
Weight: 14.5 kg - 15 pieces/m<sup>2</sup>
- **Double Side**  
Weight: 16 kg - 15.5 pieces/m<sup>2</sup>



143054

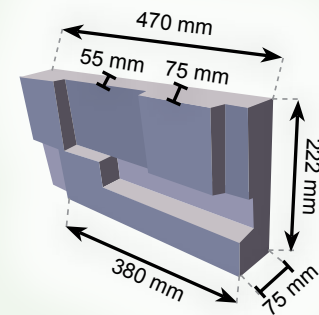

### Romani Stone

- Weight: 13.15 kg
- 9 pieces/m<sup>2</sup>

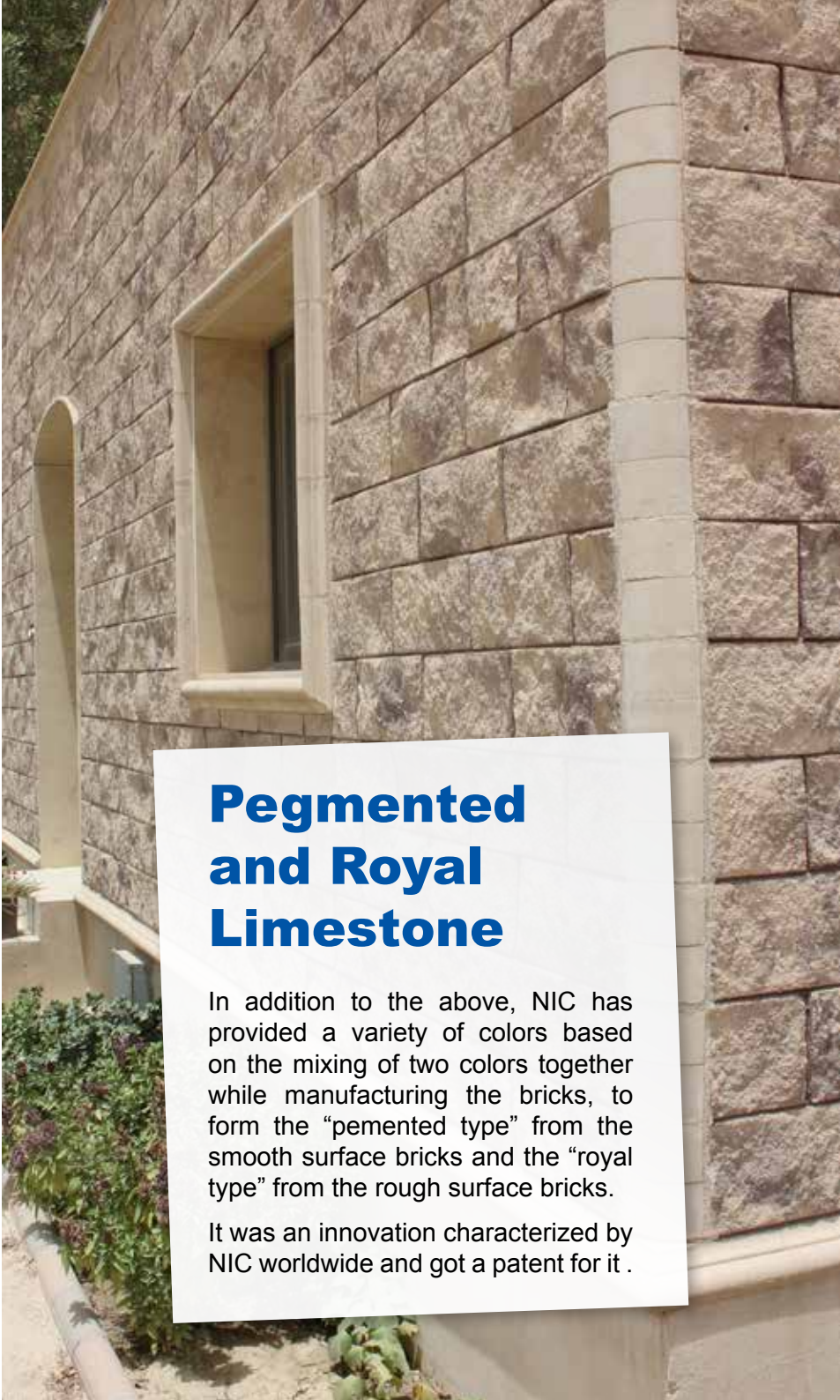

## Pegmented and Royal Limestone

In addition to the above, NIC has provided a variety of colors based on the mixing of two colors together while manufacturing the bricks, to form the “pegmented type” from the smooth surface bricks and the “royal type” from the rough surface bricks.

It was an innovation characterized by NIC worldwide and got a patent for it .



### Standard 34 Royal

- Weight: 2.25 kg
- 33 pieces/m<sup>2</sup>

Subsidized



138340

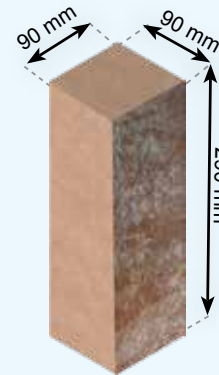

### Standard 35 Royal

- Weight: 4.5 kg
- 33 pieces/m<sup>2</sup>

Subsidized



138350

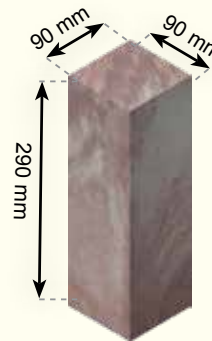

### Standard 39 Royal

- Weight: 9 kg
- 18 pieces/m<sup>2</sup>



138051

# Decorative Stone

The decorative stone is considered one of the most prominent features of the limestone products. NIC is keen to follow the development approach by providing all new and modern materials in order to keep abreast of the continuous progress in building materials and construction, which reflects the company's interest in serving its customers.

The limestone decoration products are divided into several groups: Frames, Niches, Oriels, Tabular, Star, Chamfered, Jalsa, Round Frame, Pyramidal.

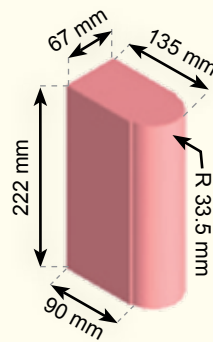

## ST.1 Curved Frame

144110

- Weight: 3.8 kg
- 56 pieces/sqm
- 3.4 piece/linear meter

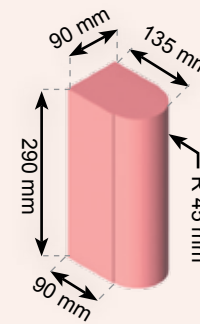

## ST.5 Curved Frame

144120

- Weight: 6.5 kg
- 33 pieces/sqm
- 3.3 piece/linear meter

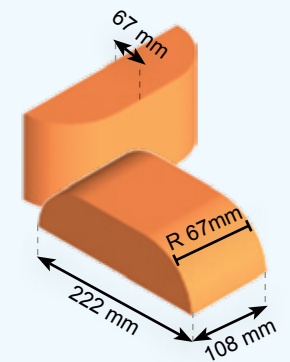

## ST.1 Border

1420380

- Weight: 2.9 kg
- 36 piece/sqm
- 13 piece/linear meter



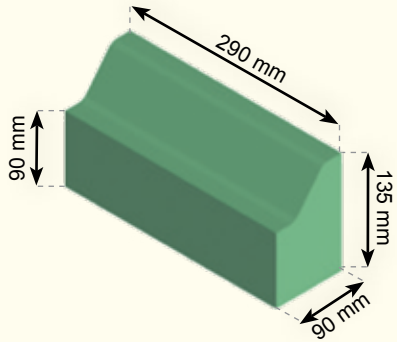

## A5 Frame

144010

- Weight: 5.5 kg
- 33 piece/sqm
- 3.3 piece/linear meter

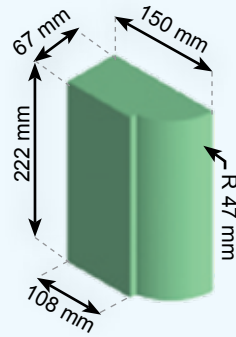

## D1 Frame

144090

- Weight: 3.75 kg
- 56 piece/sqm
- 4.3 piece/linear meter

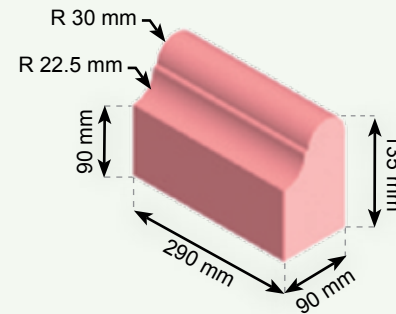

## G5 Frame

144020

- Weight: 5.75 kg
- 33 piece/sqm
- 3.3 piece/linear meter

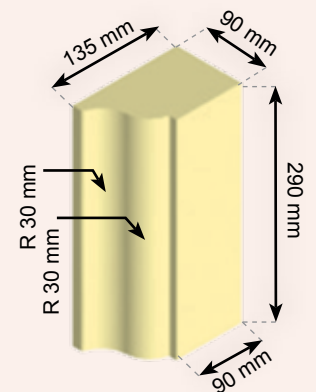

## S5 Frame

144030

- Weight: 6 kg
- 33 piece/sqm
- 3.3 piece/linear meter

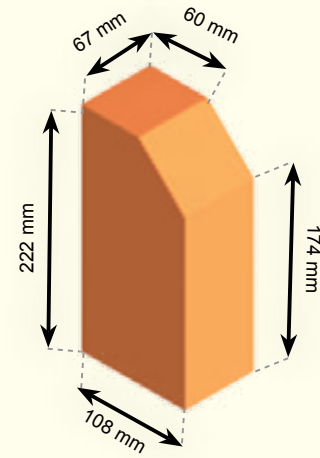

## ST.1 Chamfered

142050

- Weight: 2.9 kg
- 44 piece/sqm
- 13 piece/linear meter

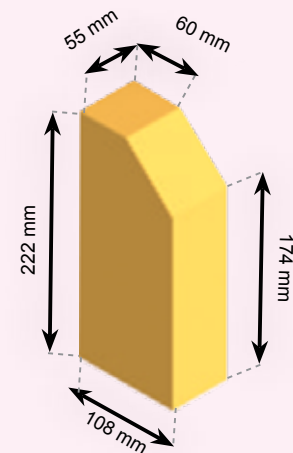

## ST.8 Chamfered

142650

- Weight: 2.5 kg
- 66 piece/sqm
- 15 piece/linear meter



## ST.1 Jalsa

142030

- Weight: 2.8 kg
- 56 piece/sqm
- 13 piece/linear meter

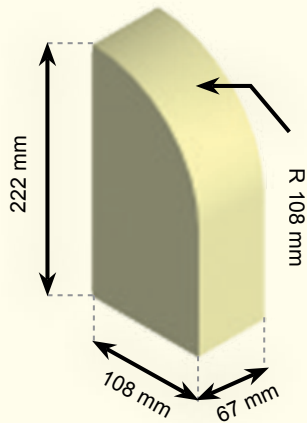

## ST.8 Jalsa

142630

- Weight: 2.5 kg
- 66 piece/sqm
- 15 piece/linear meter

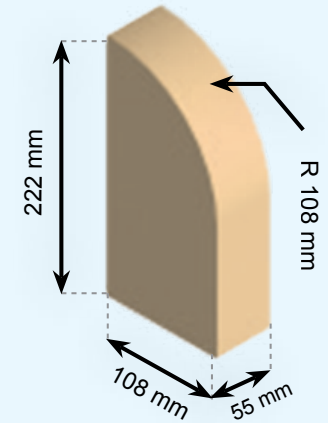

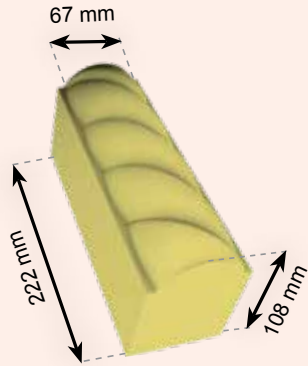

### St.1 Tabular

144170

- Weight: 3 kg
- 56 piece/sqm
- 4.3 piece/linear meter

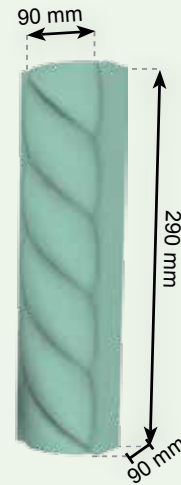

### St.5 Tabular

144180

- Weight: 4.5 kg
- 33 piece/sqm
- 3.3 piece/linear meter

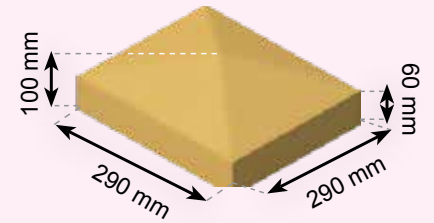

### Star

138291

- Weight: 11.5 kg
- 14 piece/sqm
- 4 piece/linear meter

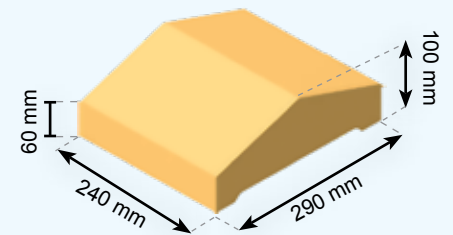

### CapStone

138292

- Weight: 10.2 kg
- 14 piece/sqm
- 4 piece/linear meter

## Column 1

142090

- Weight: 1 kg
- 82 piece/sqm
- 5.5 piece/linear meter

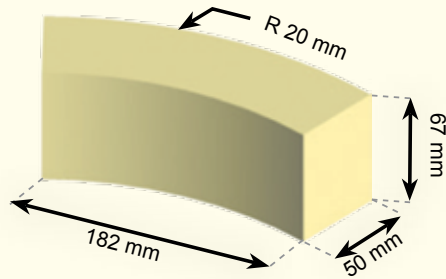

## Column 5

142490

- Weight: 1.4 kg
- 61 piece/sqm
- 5.5 piece/linear meter

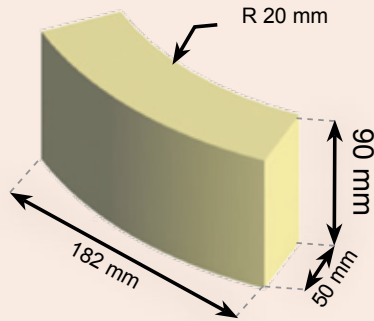

## Column 8

142690

- Weight: 0.88 kg
- 100 piece/sqm
- 5.5 piece/linear meter

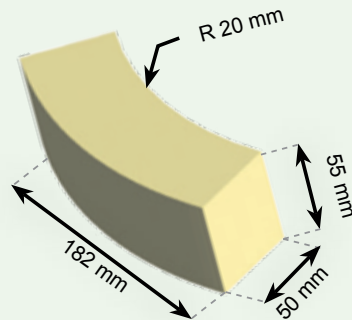



## Oriel Round

144410

- Weight: 1.85 kg
- 39 piece/sqm

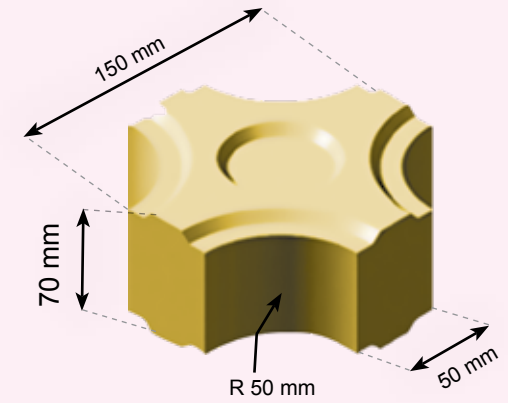

## Oriel Octagonal

144400

- Weight: 2.5 kg
- 34 piece/sqm

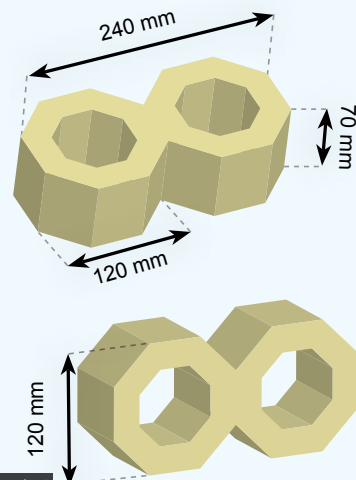

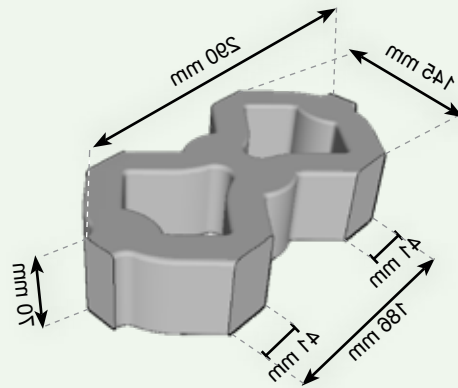

## Oriel Star

144420

- Weight: 1.9 kg
- 39 piece/sqm

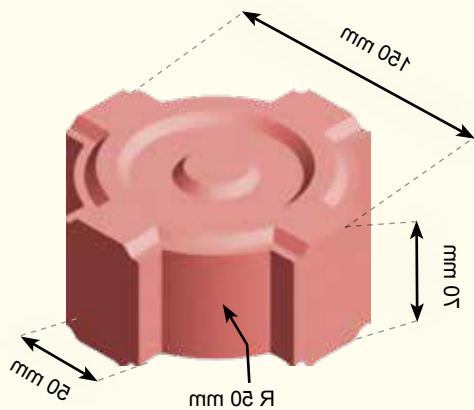

## Oriel Andalusi

144500

- Weight: 2.5 kg
- 34 piece/sqm

# Limestone Blocks

It is a suitable alternative to the other types of bricks used in fences around the house or the walls of the roofs.

These blocks have a High bearing strength for climate and heat factors..

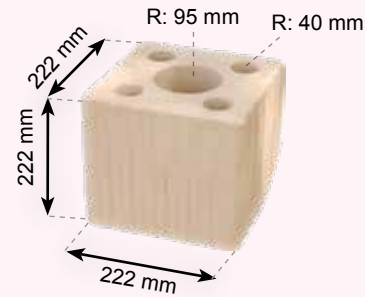

## Block 11

139110

- Weight: 16.5 kg
- 19 piece/sqm

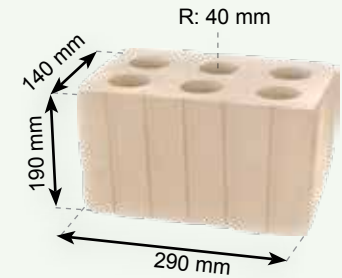

## Block 14

139140

- Weight: 12.75 kg
- 17 piece/sqm

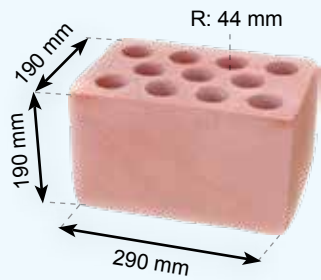

## Block 15

139150

- Weight: 15.25 kg
- 17 piece/sqm

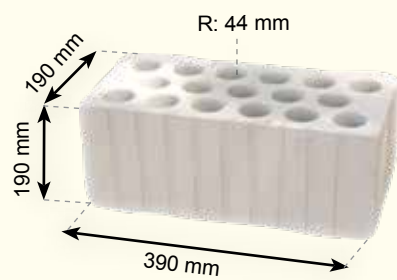

## Block 17

139170

- Weight: 20.25 kg
- 12 piece/sqm

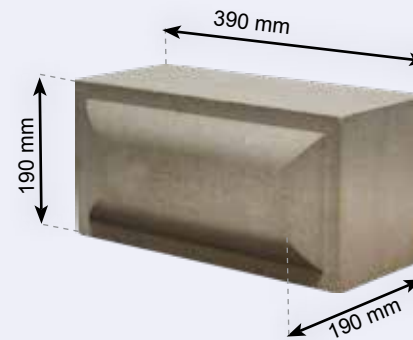

## Block 17 Protruded

139172

- Weight: 25.5 kg
- 12 piece/sqm



# Colors of Brick, Decoration, and Limestone Blocks

The colors of bricks and the limestone decorative bricks have different colors of different light and dark shades.

They remain stable for years as they are manufactured from inorganic metal oxides whose reaction phases are complete. This leaves them resistant to weather changes and changes over the years.



Light Yellow  
021



Light Red  
061

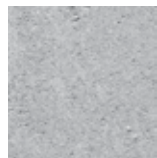

Light Grey  
081



Light Green  
041



Orange  
131



Dark Yellow  
031



Dark Red  
071



Dark Grey  
091



Dark Green  
051



Terracotta  
171



Beige  
111



Brown  
181



White  
011



Sugar  
191

## Royal and Pegmented Colors



801 Violet+White



751 Red+Yellow



711 Red+White



781 Red+Grey



721 Grey+White



791 Orange+Beige



731 Orange+White



741 Green+Yellow



701 Green+White



761 Brown+L. Yellow



681 Yellow+White



771 Brown+D. Yellow

The colors in the catalogue are not completely identical to the real colors of the product; therefore we recommend that you inspect the samples before purchasing them, without depending on the colors in the catalogue.

# Cement Cladding Stone

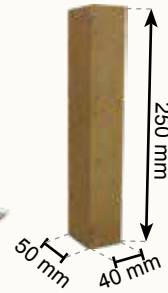

## Regular cement stone 25x4x5

- Weight: 1.13 kg
- 80 pieces/m<sup>2</sup> (installation 5 cm)
- 100 pieces/m<sup>2</sup> (installation 4 cm)

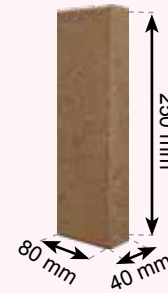

## Regular cement stone 25x4x8

- Weight: 1.80 kg
- 50 pieces/m<sup>2</sup> (installation 8 cm)
- 100 pieces/m<sup>2</sup> (installation 4 cm)



## Cement Stone GTT 25x4x5

- Weight: 1.16 kg
- 100 pieces/m<sup>2</sup> (installation 4 cm)



## Cement Stone GTT 25x4x8

- Weight: 1.82 kg
- 100 pieces/m<sup>2</sup> (installation 4 cm)

\* Calculated quantity of above pieces do not consider the area required for glue mortar

# Colors of Cement Cladding Stone

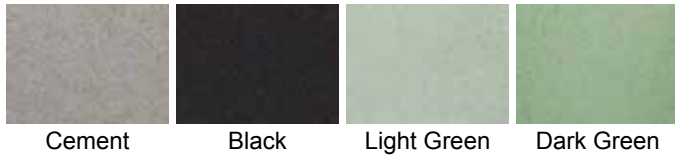

Certified material is used. The best paints are used after inspecting them at the company laboratories to guarantee quality and stability of color.

## Remarks:

- A slight difference may be noticed in the color grade due to the continuous mixing process during production. This is considered normal.
- The phenomenon of salting is a natural and temporary phenomenon and does not affect the quality of the product.
- The colors in the catalogue are not completely identical to the real colors of the product; therefore we recommend that you inspect the samples before purchasing them, without depending on the colors in the catalogue.

# Cement Blocks

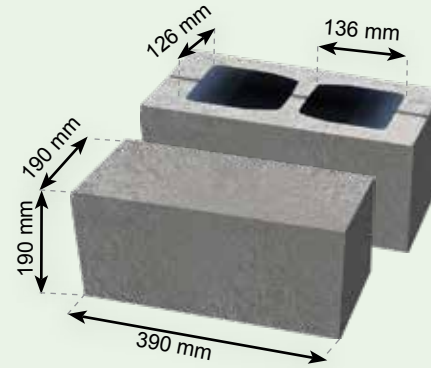

## Cement Block 39x19x19

- Weight of the filled in block: 31 kg per piece
- Weight of the hollow block: 18.5 kg per piece
- 12.5 pieces/m<sup>2</sup>

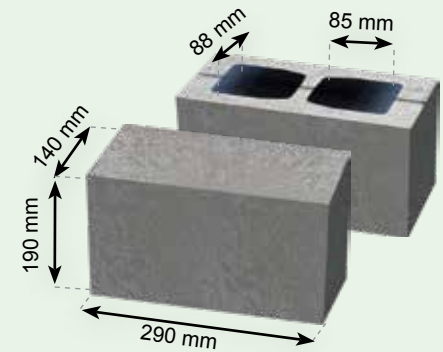

## Cement block 29x14x19

- Weight of the filled in block: 17.2 kg per piece
- Weight of the hollow block: 12.75 kg per piece
- 22.2 pieces/m<sup>2</sup>

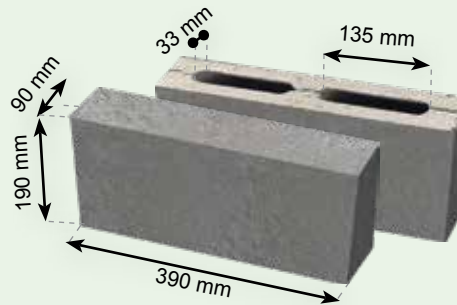

## Cement block 9x14x19

- Weight of the filled in block: 14.75 kg per piece
- Weight of the hollow block: 11.25 kg per piece
- 12.5 pieces/m<sup>2</sup>



## Cement block 39x14x19

- Weight of the filled in block: 22 kg per piece
- 16.6 pieces/m<sup>2</sup>

Loadbearing and non-loadbearing Blocks (OPC or SRC) are available as per request

# Quality Control and Assurance Management

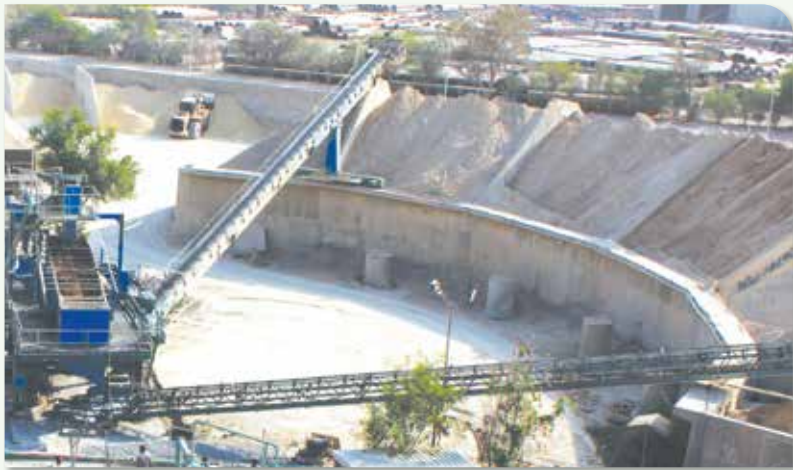

The Quality Control and Assurance Department plays a pivotal role in ensuring the highest standards of quality across all technical aspects of the company's industrial products. Its responsibilities encompass the entire production process, starting from the receipt and inspection of raw materials to verify compliance with specifications, through designing and testing various material blends. The department conducts comprehensive evaluations of raw materials, both in their fresh and hardened states, ensuring adherence to local and international technical standards as well as total quality management benchmarks.

In addition, the department oversees the calibration of plant scales, secures factory certifications from the Ministry of Public Works, and provides clients with authenticated inspection certificates.

The department is structured into three key divisions:

- Production Quality Division – Focused on maintaining and improving production standards.
- Laboratories Division – Equipped with state-of-the-art testing facilities for precise and reliable evaluations.
- Technical Specifications and Customer Service Division – Dedicated to providing expert guidance and ensuring client satisfaction.

Each division is staffed by highly qualified engineers with extensive expertise and Subsidized by cutting-edge laboratories featuring advanced testing equipment. The department also offers professional technical consultancy services to clients and project teams, further reinforcing its commitment to excellence and innovation.

# Technical Specification

The following table shows a comparison between the technical specifications of the concrete blocks, bricks and limestone blocks:

Specification	Cement Blocks	Limestone & Decor	Limestone Blocks
Compressive Strength (kg/cm <sup>2</sup> )	70	200	120
Hollow - Density (kg/m <sup>3</sup> )	2000	-	1.5
Solid - Density (kg/m <sup>3</sup> )	2000	1.9	1.9
Water Absorbance (of blocks weight, after 24 hrs.)	12%	12-15%	12-15%
Fire Resistance (hrs)	45 min - 4 hrs	2	4

The following are the technical specifications of both concrete and hollow concrete blocks according to the Kuwaiti, Gulf and international standards:

Solid Blocks	Strength (Average) N/mm <sup>2</sup>	Hollow Blocks	Strength (Average) N/mm <sup>2</sup>
Non Loadbearing Blocks	6.00 <sup>(1)</sup>	Non Loadbearing Blocks (Gross Area)	6.00 <sup>(7)</sup>
Non Loadbearing Blocks	3.00 <sup>(2)</sup>	Non Loadbearing Blocks (Gross Area)	3.00 <sup>(8)</sup>
Loadbearing Blocks	6.00 <sup>(3)</sup>	Non Loadbearing Blocks (Net Area)	4.14 <sup>(9)</sup>
Non Loadbearing Blocks	4.14 <sup>(4)</sup>	Loadbearing Blocks (Gross Area)	6.00 <sup>(10)</sup>
Loadbearing Blocks	12.00 <sup>(5)</sup>	Loadbearing Blocks (Gross Area)	7.50 <sup>(11)</sup>
Loadbearing Blocks	13.10 <sup>(6)</sup>	Loadbearing Blocks (Net Area)	13.10 <sup>(12)</sup>

(1) KWS GSO 1910/2010 | (2) BS 6073 | (3) KSS 222/1986 | (4) ASTM C129 | (5) KWS GSO 1910/2010 | (6) ASTM C-90  
 (7) KWS GSO 1911/2010 | (8) BS 6073 | (9) ASTM C129 | (10) KSS 222/1986 | (11) KWS GSO 1911/2010 | (12) ASTM C-90

## Fire Rating:

Solid Block (Lx Wx H)	Fire Rating	Hollow Block (Lx Wx H)	Fire Rating
39x19x19	4 Hr	39x19x19	1.5 Hr
29x14x19	3 Hr	29x14x19	1 Hr
39x09x19	1.5 Hr	39x09x19	45 min
39x14x19	3 Hr		

# Branches



## Headquarter Shuwaikh

South Shuwaikh  
intersection of Jahra Road  
and the Airport Road,  
Next to the  
Red Crescent Society.

Tel: 24642100  
Kuwait Hotline: 1844555

**Working Hours\*:**  
Sunday - Thursday  
7:30am - 3:00pm

## Our Section in ABYAT Showroom

Industrial Shuwaikh  
Canada Dry St.  
ABYAT Showroom  
Tel: 1848000

**Working Hours\*:**  
Saturday - Friday  
8:00am - 10:00pm



## Industrial Shuwaikh Showroom

Industrial Shuwaikh2  
Block1 - Area 92  
Al-Zaben Complex  
Shops : 12,13,14  
Tel. : 24642101/2/3/4/9  
Fax : 24642110

**Working Hours\*:**  
Saturday - Thursday  
7:00am-9:00pm



## Western Industrial Shuaiba

Tel: 24642300  
Ceramics Factory:  
23262714/10

**Working Hours\*:**  
Saturday - Thursday  
7:30am - 3:00pm



## Sulaiibiya

Tel: 24642200

**Working Hours\*:**  
Saturday - Thursday  
7:30am - 3:00pm

Follow us on social media

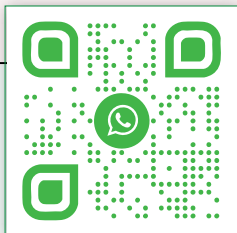

**Inquiries & Sales: 1 844 555**



**NICKKuwait1**

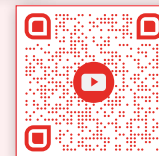

**National Industries**

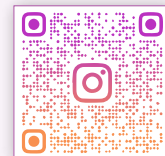

**National\_Industries**

\* Working hours are subject to change in occasions and holidays



**NATIONAL INDUSTRIES COMPANY**  **شركة الصناعات الوطنية**  
Since **1960** منذ  
[www.nicbm.com](http://www.nicbm.com)  **1 844 555**

